



PROJECT

CATALOG #

TYPE

NOTES

LL Underwater Light DESIGNER PREMIUM

Durable brass underwater light for illuminating water features. An RGBW version is also available for use with Luxor® ZDC systems.

Quick Facts

- Corrosion-resistant die-cast brass
- Natural brass with tumbled finish
- Cree® integrated LEDs
- Stainless steel mounting stand
- Tamper-resistant features
- Color temperature filters
- Compatible with Luxor technology
- Phase and PWM dimmable
- Input voltage: 10-15V

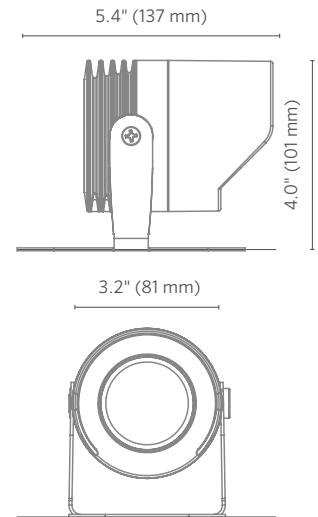

LL Specialty Light SPECIFICATIONS

Lamp	1LED	3LED	3LEDT	6LED	9LED	ZDC
Halogen Lumen Equivalent	10W	20W	20W	35W	50W	20W
Total Lumens[†]	110	225	121	445	600	140
Input Voltage	10 to 15V	10 to 15V	10 to 15V	10 to 15V	10 to 15V	11 to 15V
Input Power (W)	2.0	4.2	4.2	8.2	10.0	9.1
VA	2.4	4.5	4.5	9.7	10.7	11.0
Efficacy (Lumens/Watt)	54	54	34	54	46	26
Color Rendering Index (CRI)	84	84	--	84	84	81
Center Beam Candlepower*						
Spot (17°-20°)	400	1,100	492	2,700	3,500	170
Dimming	PWM, Phase**	PWM, Phase**	PWM, Phase**	PWM, Phase**	PWM, Phase**	--
RGBW Available	No	No	No	No	No	Yes
Luxor Compatibility						
Default	Zoning	Zoning	--	Zoning	Zoning	--
ZD Option	Zoning/ Dimming	Zoning/ Dimming	Zoning/ Dimming	Zoning/ Dimming	Zoning/ Dimming	--
ZDC Option	--	--	--	--	--	Zoning/ Dimming/ Color
Minimum Rated Life (L70)	50,000 Hrs	50,000 Hrs	50,000 Hrs	50,000 Hrs	50,000 Hrs	50,000 Hrs

* Information not available for Flood or Wide Flood.

** For optimal performance, use a trailing-edge, phase-cut dimmer.

† Measured using the 3,900K CCT lens. Multipliers for other CCTs include 0.80 (2,700K), 0.65 (4,500K), and 0.65 (5,200K).

FX Luminaire

FX Luminaire is an industry-leading manufacturer of landscape and architectural lighting products with a focus on the advancement of LED technology and digital lighting control with zoning, dimming, and color adjustment capabilities. We offer a full spectrum of highly efficient lighting fixtures that can be used to create elegant landscape lighting systems for commercial or residential applications. Our products are available exclusively via our extensive professional distributor network.

Materials

Die-cast C360 brass housing and cap with stainless steel stand.

Socket

Socket contains MoistureBlock™ technology, preventing moisture from wicking up into sealed areas of the fixture.

Finish

Natural brass, tumbled finish.

Lamp

Integrated module with Cree LEDs. Gold-plated connectors and conformal coated for maximum reliability and corrosion resistance. Proprietary on-board intelligent driver uses firmware-controlled temperature regulation, maximizing LED life. Field upgradeable and replaceable, the LEDs are rated to 50,000 hrs. Maximum drive current: 1 A.

Wiring

16 AWG (1.3 mm); 220°F (105°C); 300V; 30' (9 m) length; 0.30 PVC insulation.

Power

Input 10-15VAC/VDC 50/60Hz. Remote transformer required (specify separately).

Housing

Die-cast brass housing with capacity for 1LED, 3LED, 6LED, 9LED, or ZDC integrated LEDs.

Shroud

Die-cast brass shroud with 15° cutoff.

Optics and CCT

Polycarbonate color temperature adjustment lenses included with fixture: 2,700K (preinstalled), 3,900K (no lens), 4,500K, and 5,200K. Interchangeable optics for 10°, 20°, 30°-32°, or 55-58° distributions ordered pre-assembled to fixture. Color temperature and beam angle lenses field serviceable. For additional color filters, spread lenses, hex baffles, etc., use MR-16 sized accessories (MR-16: 1.95" (49.5 mm dia. x 1.1 mm thickness). Beam angle is calculated using LM-79 method for SSL luminaires.

Lens

Tempered glass lens with shock resistance and high tolerance for thermal expansion and stress.

Weight

4.4 lbs. (2 kg)

Manufacturing

9001:2015 ISO certified facility

Hardware

10-24 stainless steel Phillips screws for angle adjustment. Includes stainless steel stand.

Ambient Operating Temperature

-30°F to 140°F (-34°C to 60°C)

Sustainability

Innovation meets conservation in the design and manufacturing of our products. Where we can, we use recycled materials while maintaining superior functionality. Our LED products provide high-quality light at optimal energy efficiency, lifespan, and durability.

Installation Requirements

Designed for installation in any direction underwater at a maximum depth of 6' (1.8 m).

Wildlife-Friendly Lighting

Available with wildlife-friendly amber LEDs.

Control

ZD or ZDC utilizes Luxor technology to zone light fixtures in up to 250 groups, dim each group in 1% increments between 0 and 100%, or change to one of 30,000 colors with RGBW LEDs. Select the ZD option for zoning/dimming or ZDC for zoning/dimming/color. Standard fixture is zoneable with Luxor.

International Compliance

Compliant per IEC 60598-1 and IEC 60598-2-7 when selecting the "e" version.

Warranty

10-year limited warranty.

Listings

 UL LISTED 3YJ8

 RoHS COMPLIANT





LL Specialty Light ORDERING INFORMATION

Fixture	Luxor Option	Output	Compliance	Finish	Wire Lead
LL*	<input type="checkbox"/> [default] Zone	<input type="checkbox"/> 1LED 2.0W; 2.4VA	<input type="checkbox"/> [default] North America (UL-listed)	<input type="checkbox"/> BS Brass 	<input type="checkbox"/> [default] 30' (9 m) Lead
	<input type="checkbox"/> ZD Zone/Dim	<input type="checkbox"/> 3LED 4.2W; 4.5VA	<input type="checkbox"/> E Int'l (CE approved)		<input type="checkbox"/> 100 100' (30 m) Lead
		<input type="checkbox"/> 3LEDT** Wildlife-Friendly Amber (585-595 nm)			
		<input type="checkbox"/> 6LED 8.2W; 9.7VA			
		<input type="checkbox"/> 9LED 10.0W; 10.7VA			
	<input type="checkbox"/> ZDC Zone/Dim/Color	<input type="checkbox"/> [default ZDC option] 9.1W; 11.0VA			

EXAMPLE FIXTURE CONFIGURATION:
LL-ZD-6LED-E-BS-100

LL - - - - BS -



* Ships with mounting stand

** Available with ZD Luxor option only.

BEAM ANGLE LENSES: Specify Separately

Lens Options	1LED	2LED	3LED
<input type="checkbox"/> DIFFUSER 18° (preassembled)	770600	771300	771600
<input type="checkbox"/> FLOOD LENS 35° (1 notch)	1LEDFLENS	3LEDFLENS	9LEDFLENS
<input type="checkbox"/> WIDE FLOOD LENS 60° (2 notches)	1LEDWFLENS	3LEDWFLENS	9LEDWFLENS

LENS ACCESSORIES: Specify Separately

Item	Code	
<input type="checkbox"/> HEX BAFFLE MR-16 Size	250015260000	
<input type="checkbox"/> SOLITE SPREAD LENS MR-16 Size	250015240000	
<input type="checkbox"/> LINEAR SPREAD LENS MR-16 Size	250013550000	

LL Specialty Light PHOTOMETRICS

LL 3LED Illuminance at a Distance

Feet (Meters)	Center Beam	Beam Width	
	Foot-Candle (Lux)	Vertical 17.3°	Horizontal 17°
4' (1.2 m)	52 fc (560 lx)	1' (0.4 m)	1' (0.4 m)
8' (2.4 m)	13 fc (140 lx)	2' (0.7 m)	2' (0.7 m)
12' (3.7 m)	6 fc (62 lx)	4' (1.1 m)	4' (1.1 m)
16' (4.9 m)	3 fc (36 lx)	5' (1.5 m)	5' (1.5 m)
20' (6.1 m)	2 fc (23 lx)	6' (1.9 m)	6' (1.8 m)
24' (7.3 m)	1.2 fc (13 lx)	8' (2.4 m)	8' (2.4 m)

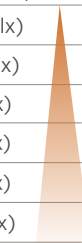

LL 3LEDT Illuminance at a Distance

Feet (Meters)	Center Beam	Beam Width	
	Foot-Candle (Lux)	Vertical 21.1°	Horizontal 20.6°
4' (1.2 m)	30 fc (325 lx)	2' (0.5 m)	2' (0.5 m)
8' (2.4 m)	8 fc (82 lx)	3' (0.9 m)	3' (0.9 m)
12' (3.7 m)	3 fc (37 lx)	5' (1.4 m)	4' (1.3 m)
16' (4.9 m)	1.9 fc (21 lx)	6' (1.8 m)	6' (1.8 m)
20' (6.1 m)	1.2 fc (13 lx)	8' (2.3 m)	7' (2.2 m)
24' (7.3 m)	0.8 fc (9 lx)	9' (2.7 m)	9' (2.7 m)

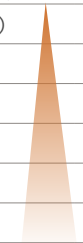

LL 6LED Illuminance at a Distance

Feet (Meters)	Center Beam	Beam Width	
	Foot-Candle (Lux)	Vertical 16°	Horizontal 17°
4' (1.2 m)	118 fc (1,265 lx)	1' (0.3 m)	1' (0.4 m)
8' (2.4 m)	29 fc (317 lx)	2' (0.7 m)	2' (0.7 m)
12' (3.7 m)	13 fc (141 lx)	3' (1.0 m)	4' (1.1 m)
16' (4.9 m)	7 fc (79 lx)	5' (1.4 m)	5' (1.4 m)
20' (6.1 m)	5 fc (51 lx)	6' (1.7 m)	6' (1.8 m)
24' (7.3 m)	3 fc (30 lx)	7' (2.2 m)	8' (2.3 m)



LL 9LED Illuminance at a Distance

Feet (Meters)	Center Beam	Beam Width	
	Foot-Candle (Lux)	Vertical 16.6°	Horizontal 17°
4' (1.2 m)	150 fc (1,615 lx)	1' (0.4 m)	1' (0.4 m)
8' (2.4 m)	38 fc (404 lx)	2' (0.7 m)	2' (0.7 m)
12' (3.7 m)	17 fc (180 lx)	4' (1.1 m)	4' (1.1 m)
16' (4.9 m)	9 fc (101 lx)	5' (1.4 m)	5' (1.4 m)
20' (6.1 m)	6 fc (65 lx)	6' (1.8 m)	6' (1.8 m)
24' (7.3 m)	4 fc (39 lx)	8' (2.3 m)	8' (2.3 m)



LL ZDC Illuminance at a Distance

Feet (Meters)	Center Beam	Beam Width	
	Foot-Candle (Lux)	Vertical 43°	Horizontal 43°
4' (1.2 m)	12 fc (129 lx)	3' (1.0 m)	3' (1.0 m)
8' (2.4 m)	3 fc (31 lx)	6' (1.9 m)	6' (1.9 m)
12' (3.7 m)	1.3 fc (14 lx)	9' (2.8 m)	9' (2.9 m)
16' (4.9 m)	0.7 fc (8 lx)	12' (3.8 m)	13' (3.8 m)
20' (6.1 m)	0.5 fc (5 lx)	16' (4.7 m)	16' (4.8 m)
24' (7.3 m)	0.3 fc (3 lx)	19' (5.7 m)	19' (5.8 m)

